



# CleanSwitch

Contact-free switch for convenient activation of entrances  
with strict hygiene and design requirements



## Hygienic, attractive, integrable

- Contact-free, hygienic door opening
- Attractive design with visual feedback
- Compatible with standard flush-mounted boxes

# CleanSwitch

## Contact-free switch for convenient activation

### Hygienic in every application

Any place in which groups of people are found can be a breeding ground for germs and other pathogens. Contact surfaces – and in particular, door handles – are responsible for spreading vast amounts of bacteria and viruses, some of which can pose a real risk to health. This becomes critical when it affects healthcare facilities. Strict hygiene standards are also imposed in the catering industry, as well as other fields in which food is prepared.

CleanSwitch provides a contact-free, hygienic method of opening doors. It works by means of a deliberate hand gesture within the detection range of 10 to 50 centimetres – helping to stop germs in their tracks. Thanks to its attractive design featuring coloured LED feedback, CleanSwitch is an appealing, user-friendly addition to its environment. It takes just a few minutes to get the activation switch up and running and installation can be carried out in any standard flush-mounted box. The highly durable front can be treated using standard surface disinfectants in hospital areas. To ensure that it can be used without any problems in particularly moist or wet environments, CleanSwitch offers reliable protection that meets IP65.

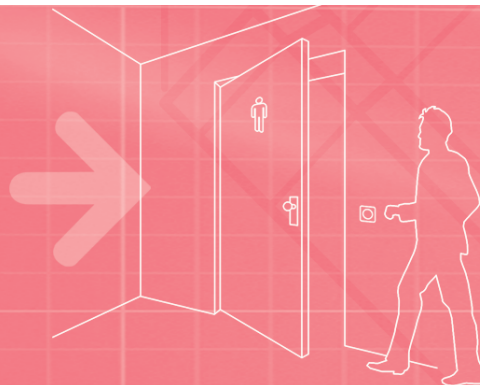

## Benefits for you

### Hygiene

CleanSwitch has been specifically developed for use in buildings subject to strict hygiene requirements, such as healthcare facilities, sanitary areas and the catering industry. It activates entrance points using a contact-free method – a deliberate gesture made by the user – and otherwise keeps doors closed. This helps to prevent the spread of germs. CleanSwitch can also be treated with any standard cleaning agent or disinfectant.

### Easy installation

The intelligent way in which the system has been designed ensures it is compatible with all standard flush-mounted boxes. CleanSwitch is extremely quick and easy to install. Set-up of the device is an intuitive process that requires no tools – and the integrated short guide provides a helping hand.

### Customising

CleanSwitch's visually appealing, straightforward design can be adapted in a whole range of ways to suit customers' preferences. It takes just a few seconds to change the colour, level of brightness and mode of the optical feedback – without tools. Not only that, but Bircher also supplies a wide selection of pictograms that can be printed onto the front of the device to make it even more user-friendly. Customised pictograms and logos can also be applied on request.

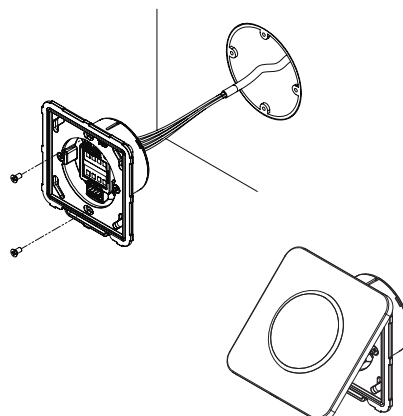

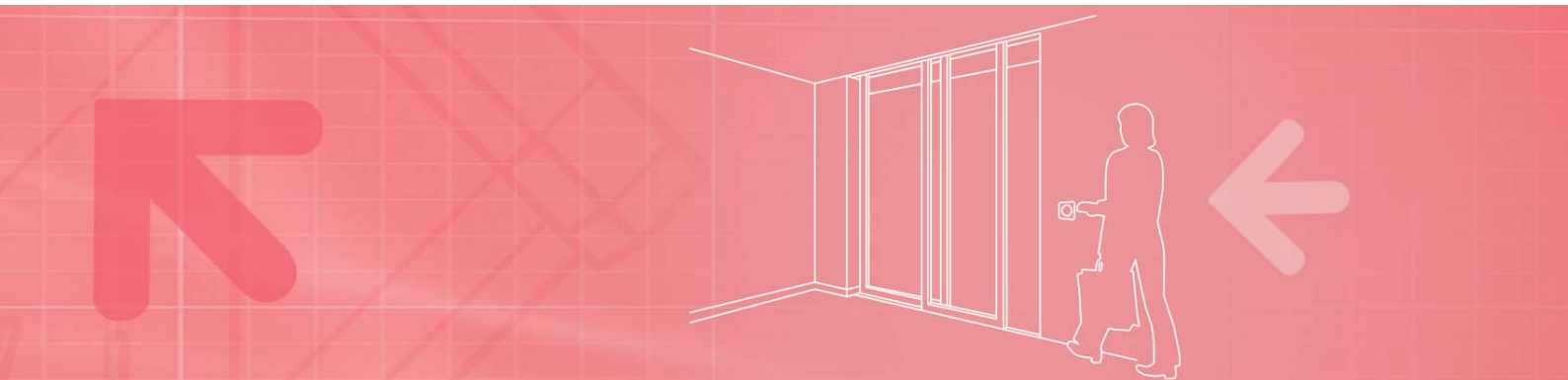

## Reliable in every application

### Situation

Hospitals, clinics, retirement homes

### Solution

- CleanSwitch provides a convenient, contact-free entrance activation method that does away with the need for contact with door handles – which are often contaminated. CleanSwitch can be treated with any standard cleaning agent or disinfectant. The high-contrast LED feedback is easy to identify for people with impaired vision.

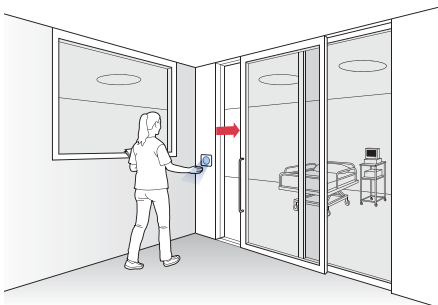

### Situation

Public sanitary areas

### Solution

- CleanSwitch provides a contact-free method of opening automatic doors to public sanitary areas, and prevents the spread of bacteria and other pathogens.

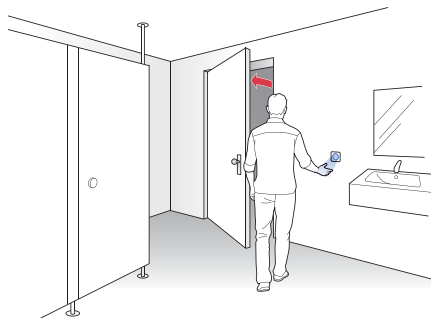

### Situation

Catering industry

### Solution

- CleanSwitch activates the door by means of a gesture. This means that the entrance to the kitchen is only opened when required – providing service staff with a convenient, hygienic door-opening solution.

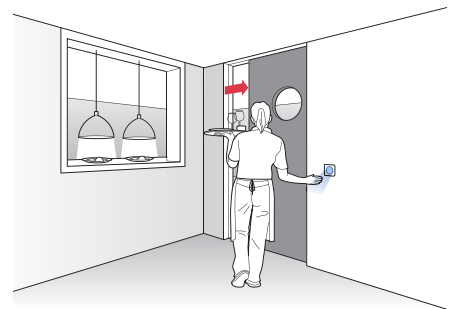

## Technical data

### Mechanical data

Material	ASA / PC
Dimensions	88 × 88 × 38 mm (L×W×D)
Weight	55 g
Connection type	Plug terminals
Colour	White

### Electrical data

Operating voltage	12~24 V AC ±10% (50~60 Hz) 12~24 V DC +20%/−10%
Frequency range	50~60 Hz
Power consumption	~ 1 W
Output	Potential-free relay with changeover contact
Max. switching voltage	(DC) 1 A to 30 V, 0.5 A to 60 V (AC) 1 A to 60 V, 0.5 A to 125 V
Max. switching capacity	30 W (DC) / 60 VA (AC)
Output fall-delay time	Relay fall-delay time 0.3 s LED fall-delay time 2 s

### Technological data

Technology	Radar
Transmission frequency	24.125 GHz
Detection range	0.1~0.5 m
Detection mode	– Pulse mode: Detector is triggered by movement of hand – Toggle mode: first movement door open / second movement door closed
Detection speed	Min. 5 Hz or ± 3 cm/s Max. 200 Hz or ± 1.2 m/s

### Ambient conditions

Protection class	IP65
Storage / operation temperature	−20° C to +60° C
Air humidity	< 95% rel., non-condensing

### Electromagnetic compatibility standards

Directives	RoHS 2011/65/EU RED 2014/53/EU
Immision	EN 61000-6-2
Emission	EN 61000-6-3

## Variants and accessories

### Description

#### CleanSwitch

Hygienic switch with optical feedback



#### CleanSwitch Basic

Hygienic switch



### Cover/Pictograms

Printed on

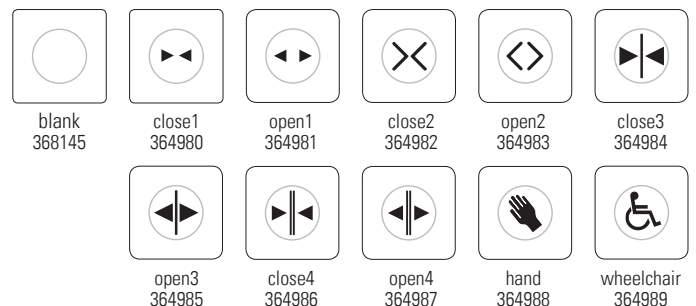

### BBC Bircher Smart Access

Wiesengasse 20  
8222 Beringen  
Switzerland  
Phone +41 52 687 11 11  
info@bircher.com  
www.bircher.com

## Ordering information

<b>CleanSwitch</b>	/	<b>wt</b>	/	<b>close1</b>
<b>Type</b> CleanSwitch CleanSwitch Basic		<b>Colour</b> wt = white		<b>Pictogram</b> blank close1 open1 ...